

Guma lita

Objaśnienie oznaczeń

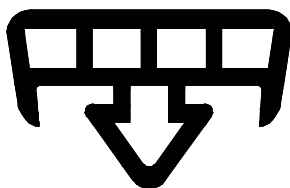

AU 9999

oznacza

nr profilu

EP / s / 9999

oznacza

rodzaj materiału / kolor / nr artykułu

ws = warstwa samoprzylepna

Rodzaj materiału

CR	neopren
EP	EPDM
NBR	perbunan
NK	kauczuk naturalny
Si	silikon
SPS	pianka silikonowa
FPM	VITON®
PVC	zmiękczone PCW
SBR	Buna (styren-butadien)

Kolor

s	czarny
g	szary
w	biały
az	antracyt
bg	beżowy
br	brązowy
hg	jasno szary
rb	ceglasty
t	przezroczysty
r	czerwony
x	kolor do wyboru

VITON® = Zastrzeżony znak towarowy firmy DuPont

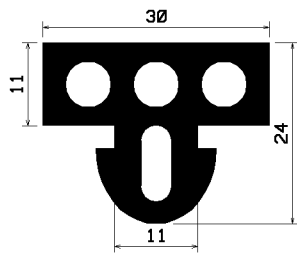

AU139
EP/s/ 1620
NK/w/1621

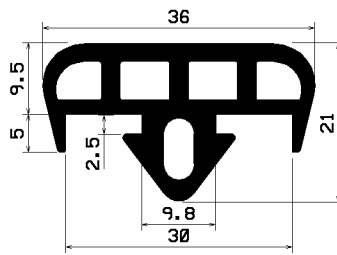

AU140
EP/s/ 1619
EP/w/ 3956

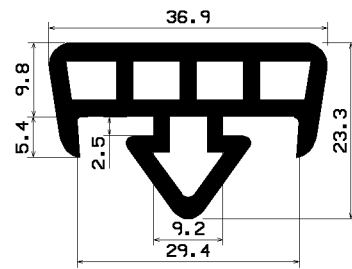

AU140/1
EP/s/ 6035
PVC/s/ 8594

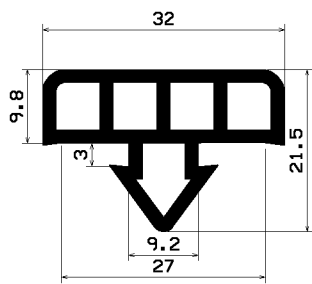

AU140/2
EP/s/ 6489
PVC/s/ 8595

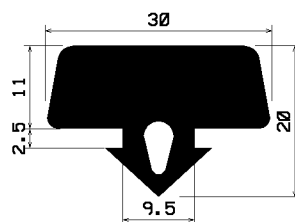

AU319
EP/s/ 3346
Si/v/ 7671
PVC/s/ 8596

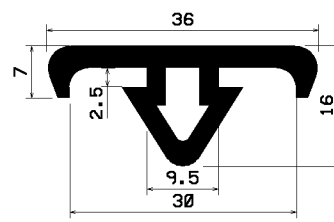

AU1131
EP/s/ 3740

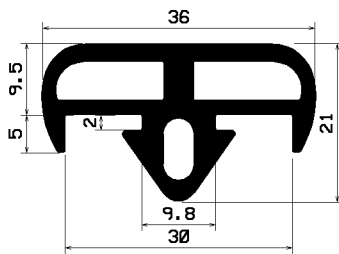

AU1528
EP/s/ 4883

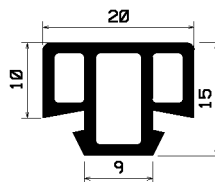

AU1531
EP/g/ 4761

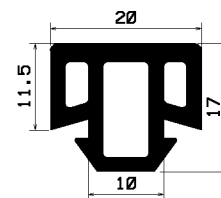

AU1549
EP/g/ 4803

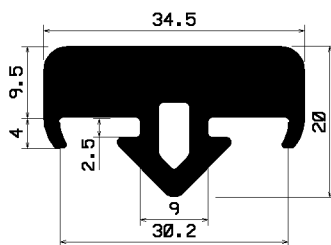

AU1583
EP/s/ 5784
PVC/s/ 8597

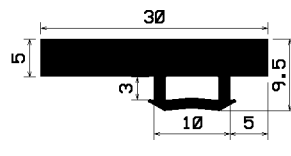

AU1690
EP/s/ 5748

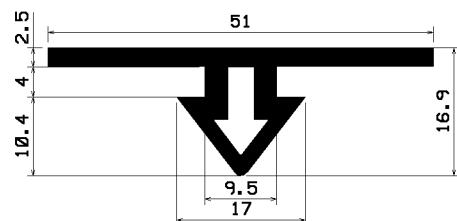

AU1938
Si/v/ 6672

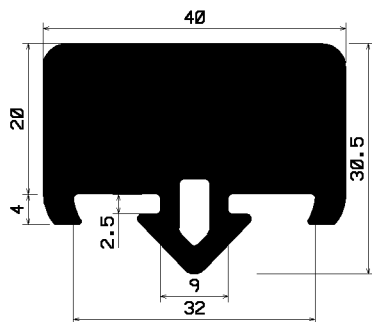

AU2103
EP/s/ 7280

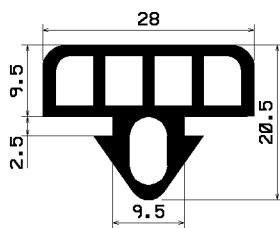

AU2324
EP/s/ 8072
PVC/s/ 8598

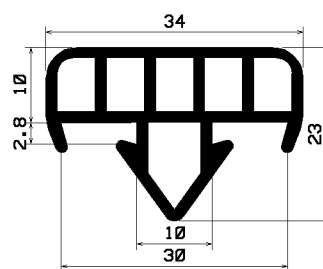

AU2482
EP/s/ 7511
PVC/s/ 8598

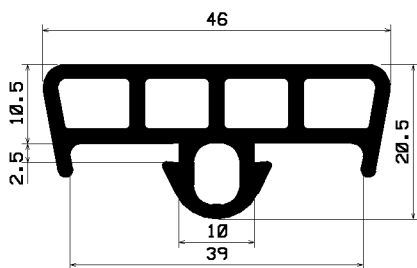

AU2504
EP/w/ 8404